

REVISIONS				
ZONE	REV	DESCRIPTION	Date	APPROVED

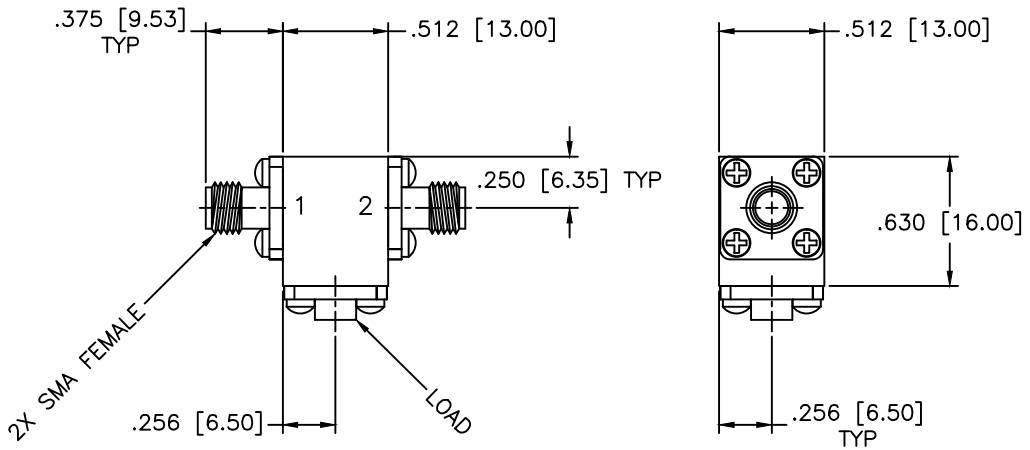

SPECIFICATIONS

Frequency Range: 17.7–20.2 GHz
 Isolation: 23dB Min.
 Insertion loss: 0.40dB Max.
 VSWR: 1.15:1 Max.
 Operating Temperature: –54°C to +85°C
 Circulator Power: 25W Avg, 250W Peak

MATERIAL:		MCLI MICROWAVE COMMUNICATIONS LABORATORIES INC. 7255 30TH AVE. N. SAINT PETERSBURG, FL 33710 TEL: (727) 344-6254 FAX: (727) 381-6116 http://www.mcli.com	SCALE:	N/A
			SHEET:	N/A
		UNLESS OTHERWISE SPECIFIED: TOLERANCES IN (INCHES) OR [mm] (MILLIMETERS) FRACTIONS: ± 1/64 DECIMALS: ±.01 ±.005 ANGLE: ±1/2°	DRAWING TITLE: COAXIAL ISOLATOR	
DRAWN: Paiboon Luekhamhan		DATE: 03-16-2009	PART NO. IS-83	
APPROVED: T. Nguyen		DATE: 03-16-2009	CAGE CODE: OD2L5	SIZE: N/A REV: N/A DWG NO. 84304
		THIRD ANGLE PROJECTION	DO NOT SCALE THE DRAWING	