

REVISIONS				
ZONE	REV	DESCRIPTION	DATE	APPROVED

PART NUMBER / FREQUENCY
FAN-4-dB DC to 2.0 GHz
FAN-5-dB DC to 4.0 GHz
FAN-6-dB DC to 6.0 GHz
FAN-23-dB DC to 18.0 GHz

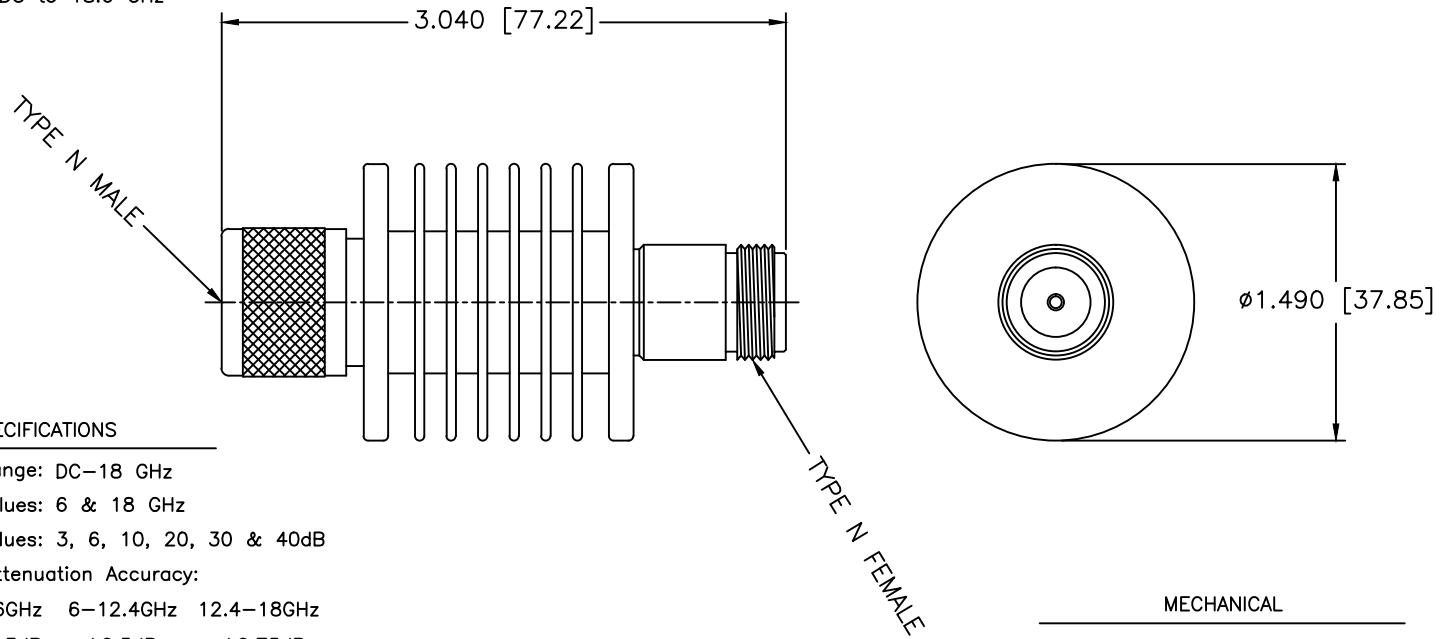

SPECIFICATIONS

Frequency Range: DC-18 GHz
 Standard Frequency Values: 6 & 18 GHz
 Common dB Values: 3, 6, 10, 20, 30 & 40dB
 Attenuation Accuracy:

	DC-6GHz	6-12.4GHz	12.4-18GHz
3dB & 6dB	±0.3dB	±0.5dB	±0.75dB
10dB & 20dB	±0.5dB	±0.75dB	±1.0dB
30dB & 40dB	±.75dB	±1.0dB	±1.5dB

VSWR:

DC to 6GHz	1.20:1 Max.
6 to 12.4GHz	1.30:1 Max.
12.4 to 18GHz	1.40:1 Max.

Input Power: 20W Avg. @ 25°C
 Derated Linearly to 4 Watts @ 125°C
 Peak Power: 500W Max.
 Operating Temperature: -65°C to +125°C
 Impedance: 50 ohms

MECHANICAL

Connector Shell: Stainless Steel
 Connector Contact: Gold Plated Beryllium Copper
 Housing: Aluminum

MATERIAL:			MICROWAVE COMMUNICATIONS LABORATORIES INC. 7255 30TH AVE. N. SAINT PETERSBURG, FL 33710 TEL: (727) 344-6254 FAX: (727) 381-6116 http://WWW.MCLI.COM		SCALE:	N/A
			UNLESS OTHERWISE SPECIFIED: TOLERANCES IN (INCHES) OR [mm] (MILLIMETERS) FRACTIONS: ± 1/64 DECIMALS: ±.020 ANGLE: ±1/2°		SHEET:	N/A
DRAWING TITLE:		20 WATTS ATTENUATOR, TYPE N				
PART NO.:		FAN-5-dB				
DRAWN:	DATE:	PROPRIETARY NOTICE: THE INFORMATION IN THIS DRAWING IS PROPRIETARY AND SHALL NOT BE USED OR DISCLOSED WITHOUT WRITTEN PERMISSION FROM MICROWAVE COMMUNICATIONS LABORATORIES INC. (MCLI) THIRD ANGLE PROJECTION	CAGE CODE:	SIZE:	REV:	DWG NO.:
APPROVED:	DATE:		OD2L5	A	N/A	83825
		DO NOT SCALE THE DRAWING				