

REVISIONS				
ZONE	REV	DESCRIPTION	DATE	APPROVED

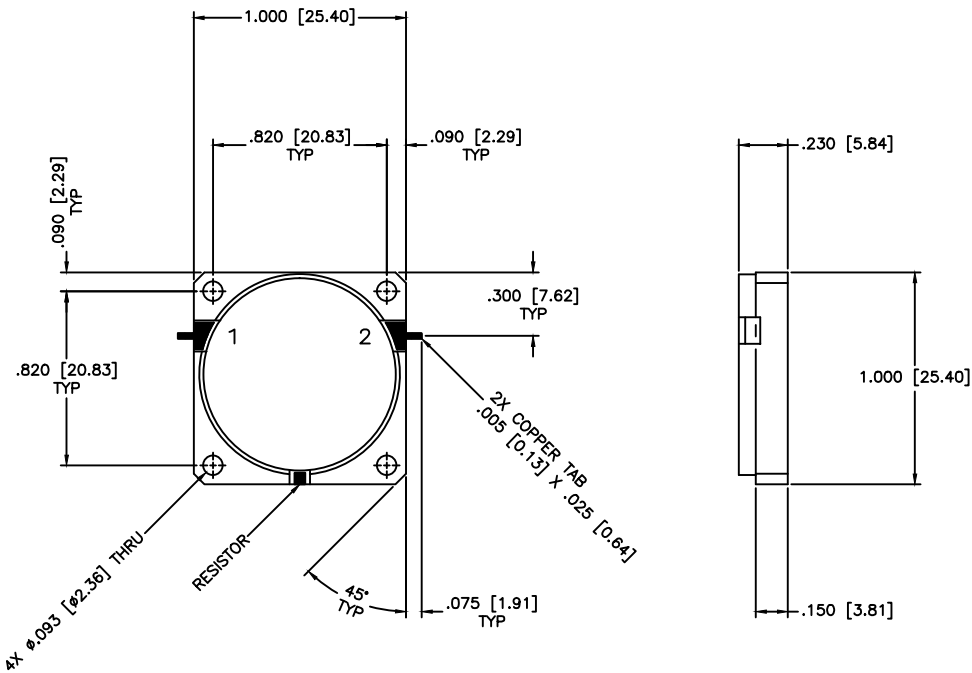

SPECIFICATIONS

Frequency Range: 1.2–1.4 GHz
 Insertion Loss: 0.5dB Max.
 Isolation: 20dB Min.
 VSWR: 1.22:1 Max.
 Impedance Nominal: 50 Ohms
 Power Rating: 5 Watts
 Operating Temperature: –45°C to +85°C
 Storage Temperature: –55°C to +100°C

MATERIAL:			MICROWAVE COMMUNICATIONS LABORATORIES INC. 7255 30TH AVE. N. SAINT PETERSBURG, FL 33710 TEL: (727) 344-6254 FAX: (727) 381-6116 http://WWW.MCLI.COM		SCALE:	N/A	
			UNLESS OTHERWISE SPECIFIED: TOLERANCES IN (INCHES) OR [mm] (MILLIMETERS) FRACTIONS: ± 1/64 DECIMALS: ±.02 ±.008 ANGLE: ±1/2°	DRAWING TITLE:		DROP-IN ISOLATOR	
DRAWN:		DATE:		PART NO.		DI-2	
Paiboon Luekhamhan 01-05-2005		T. Nguyen 01-05-2005		CAGE CODE:		SIZE:	REV:
		PROPRIETARY NOTICE: THE INFORMATION IN THIS DRAWING IS PROPRIETARY AND SHALL NOT BE USED OR DISCLOSED WITHOUT WRITTEN PERMISSION FROM MICROWAVE COMMUNICATIONS LABORATORIES INC. (MCLI)		OD2L5		N/A	N/A
		THIRD ANGLE PROJECTION 		DO NOT SCALE THE DRAWING		DWG NO. 82135	