

REVISIONS				
ZONE	REV	DESCRIPTION	DATE	APPROVED

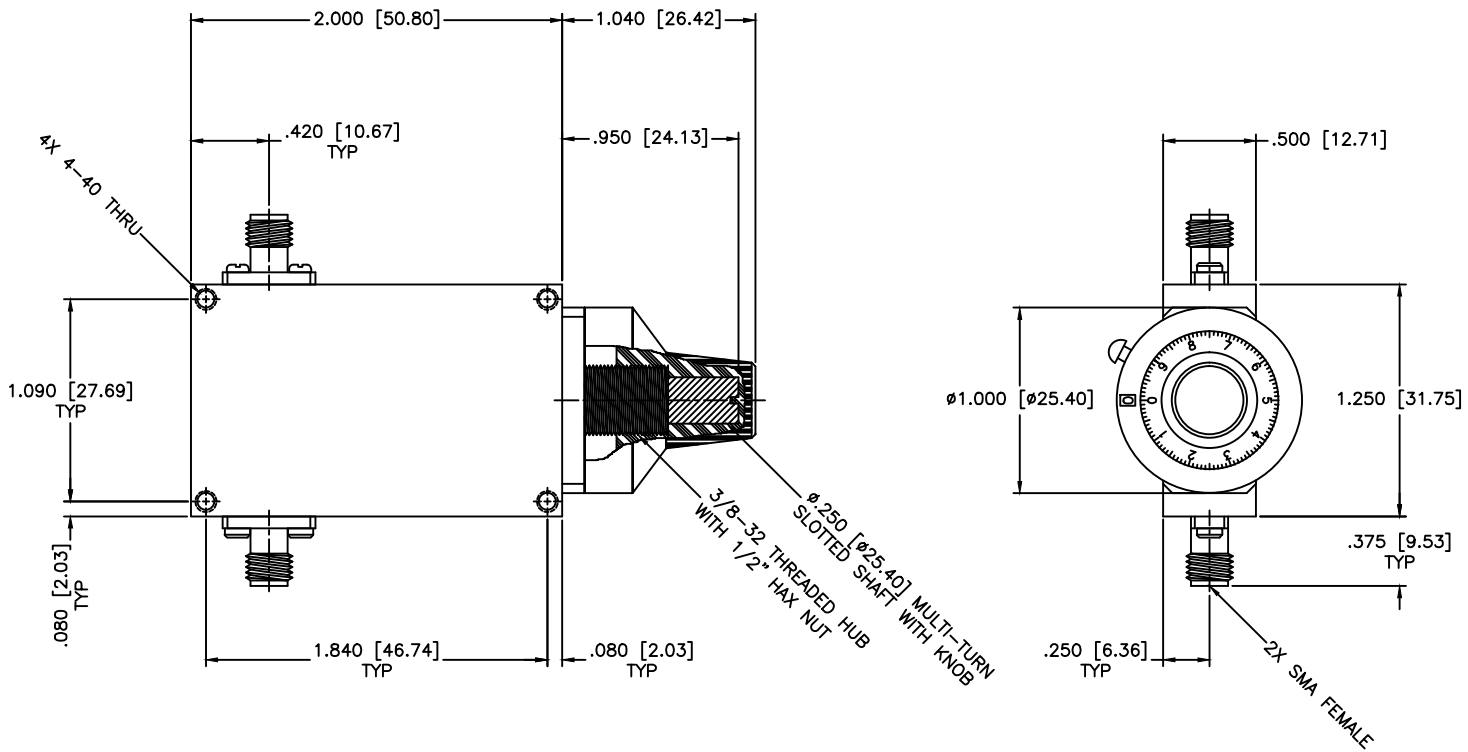

SPECIFICATIONS

Frequency Range: 3.7-4.2 GHz
 Attenuation: 30dB
 Insertion Loss: 0.5dB Max.
 VSWR: 1.50:1 Max.
 RF Power: 7W Avg. 3kW Peak

ENVIRONMENTAL

Temperature Range: -55°C to +110°C
 Shock: 15 G's, 11mS, 1/2 sine
 Vibration: 3 G's overall
 Altitude: 40,000ft. Survival 25,000ft Operating

MATERIAL:	
DRAWN:	DATE:
Pai boon Luekhamhan	02-08-2011
APPROVED:	DATE:
T. Nguyen	02-08-2011

	MICROWAVE COMMUNICATIONS LABORATORIES INC. 7255 30TH AVE. N. SAINT PETERSBURG, FL 33710 TEL: (727) 344-6254 FAX: (727) 381-6116 http://WWW.MCLI.COM		SCALE:	N/A
	UNLESS OTHERWISE SPECIFIED: TOLERANCES IN (INCHES) OR [mm] (MILLIMETERS) FRACTIONS: ± 1/64 DECIMALS: ±.01 ±.005 ANGLE: ±1/2°		SHEET:	N/A
DRAWING TITLE:		CONTINUOUSLY VARIABLE ATTENUATOR WITH DIAL		
PART NO.		CVA6-30/D		
CAGE CODE:	SIZE:	REV:	DWG NO.	
OD2L5	A	N/A	85414	
DO NOT SCALE THE DRAWING				