

REVISIONS				
ZONE	REV	DESCRIPTION	Date	APPROVED

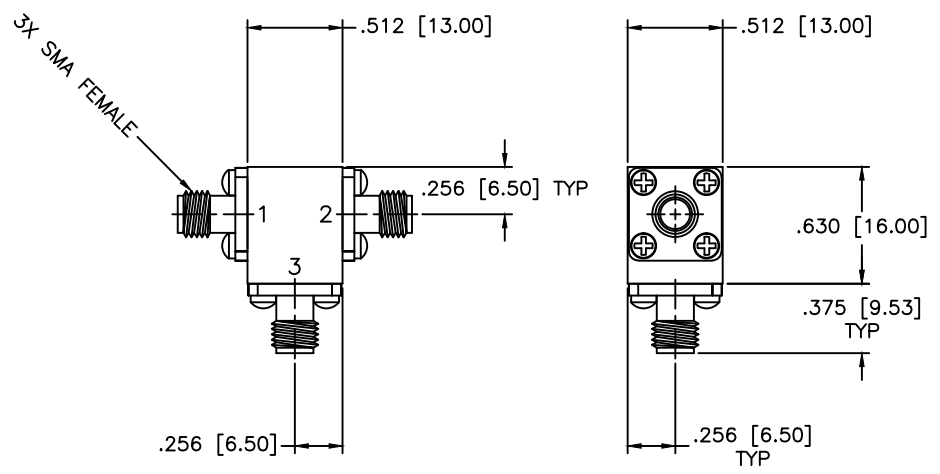

SPECIFICATIONS

Frequency Range: 17.7–20.2 GHz
 Isolation: 23dB Min.
 Insertion loss: 0.40dB Max.
 VSWR: 1.15:1 Max.
 Circulator Power: 25W Avg, 250W Peak.
 Operating Temperature: -54°C to +85°C

MATERIAL:		MCLI MICROWAVE COMMUNICATIONS LABORATORIES INC. 7255 30TH AVE. N. SAINT PETERSBURG, FL 33710 TEL: (727) 344-6254 FAX: (727) 381-6116 http://WWW.MCLI.COM	SCALE:	N/A
			SHEET:	N/A
UNLESS OTHERWISE SPECIFIED: TOLERANCES IN (INCHES) OR [mm] (MILLIMETERS) FRACTIONS: ± 1/64 DECIMALS: ±.01 ±.005 ANGLE: ±1/2°		DRAWING TITLE: COAXIAL CIRCULATOR		
DRAWN: Paiboon Luekhamhan		PART NO. CS-83		
DATE: 05-18-2010		CAGE CODE: OD2L5		
APPROVED: T. Nguyen		DATE: 05-18-2010		
THIRD ANGLE PROJECTION		SIZE: A		
		REV: N/A		
		DWG NO. 84806		
DO NOT SCALE THE DRAWING				