

REVISIONS				
ZONE	REV	DESCRIPTION	DATE	APPROVED

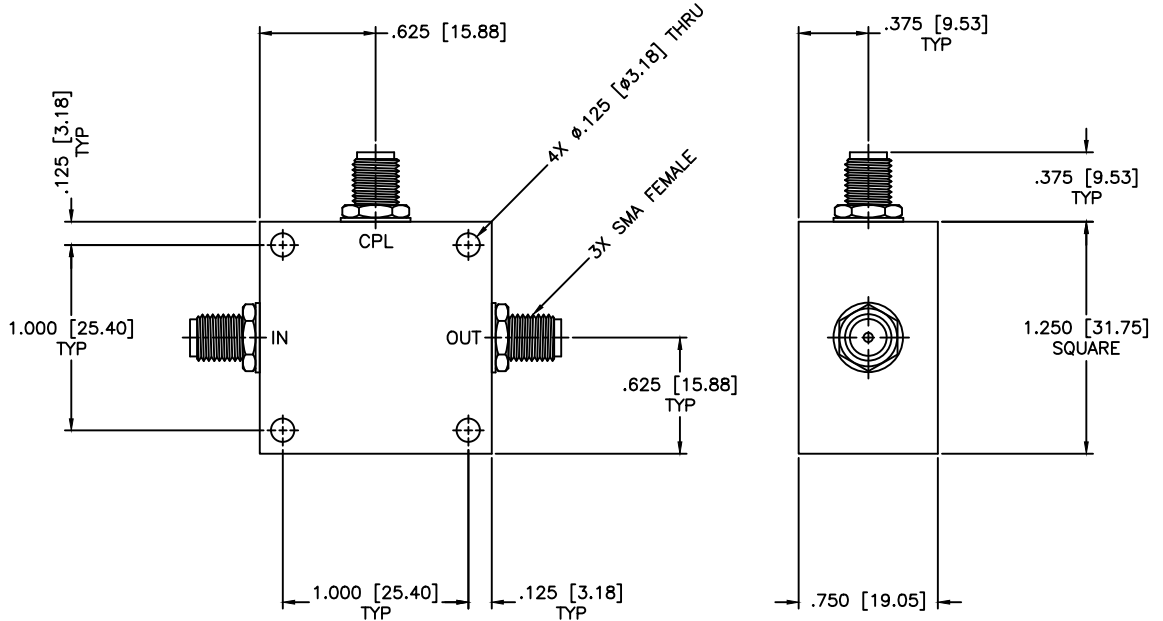

SPECIFICATIONS

Frequency Range: 5–1000 MHz
 Coupling: 15±0.5dB
 Insertion Loss: 1.5dB Max.
 Flatness: ±0.5dB
 Directivity: 20dB Min.
 VSWR: 1.30:1 Max.
 Operating Temperature: –55°C to +85°C

MATERIAL:		MICROWAVE COMMUNICATIONS LABORATORIES INC. 7255 30TH AVE. N. SAINT PETERSBURG, FL 33710 TEL: (727) 344-6254 FAX: (727) 381-6116 http://WWW.MCLI.COM	SCALE:	N/A
			SHEET:	N/A
		UNLESS OTHERWISE SPECIFIED: TOLERANCES IN (INCHES) OR [mm] (MILLIMETERS) FRACTIONS: ± 1/64 DECIMALS: ±.01 ±.005 ANGLE: ±1/2°	DRAWING TITLE: DIRECTIONAL COUPLER	
		PROPRIETARY NOTICE: THE INFORMATION IN THIS DRAWING IS PROPRIETARY AND SHALL NOT BE USED OR DISCLOSED WITHOUT WRITTEN PERMISSION FROM MICROWAVE COMMUNICATIONS LABORATORIES INC. (MCLI)	PART NO. CL5-16	
DRAWN:	DATE:	THIRD ANGLE PROJECTION 	CAGE CODE:	SIZE:
Paiboon Luekhamhan	10-04-1999		OD2L5	A
APPROVED:	DATE:		REV:	DWG NO.
T. Nguyen	10-04-1999		N/A	82595
			DO NOT SCALE THE DRAWING	