

REVISIONS				
ZONE	REV	DESCRIPTION	DATE	APPROVED

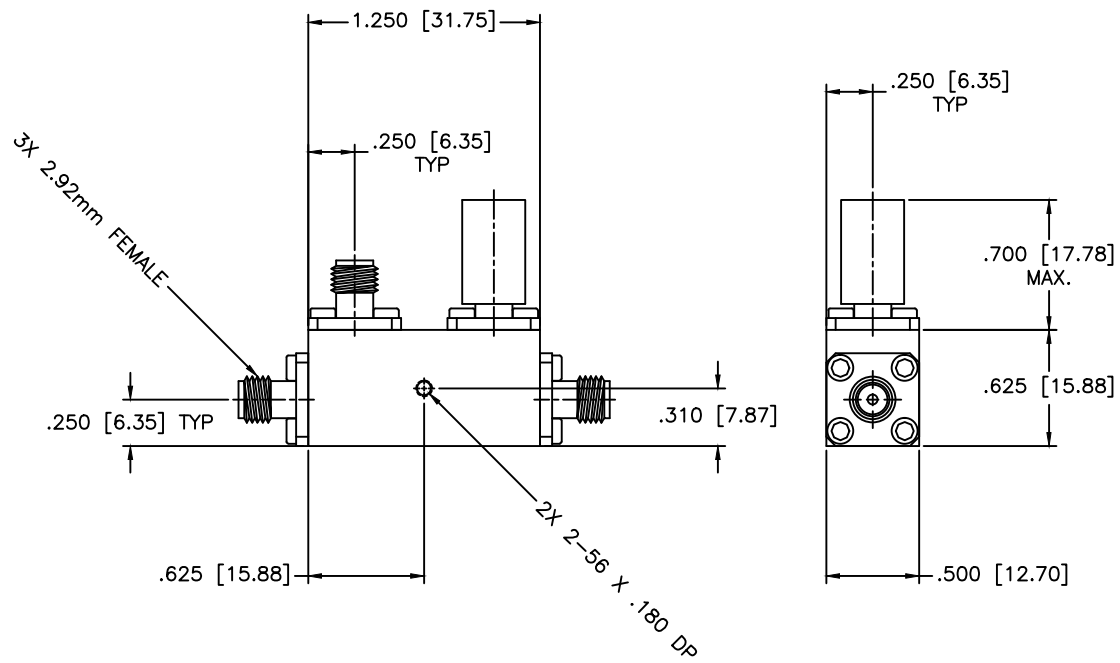

SPECIFICATIONS

Frequency Range: 26.5–40 GHz
 VSWR: 1.70:1 Max.
 Coupling: 30±1.0dB
 Insertion Loss: 1.2dB Max.
 Directivity: 12dB Min.
 Frequency Sensitivity: ±0.7dB
 Power Rating: 20W Avg, 3kW Peak
 Operating Temperature: -32°C to +85°C

MATERIAL:		MICROWAVE COMMUNICATIONS LABORATORIES INC. 7255 30TH AVE. N. SAINT PETERSBURG, FL 33710 TEL: (727) 344-6254 FAX: (727) 381-6116 http://WWW.MCLI.COM	SCALE:	N/A
			SHEET:	N/A
		UNLESS OTHERWISE SPECIFIED: TOLERANCES IN (INCHES) OR [mm] (MILLIMETERS) FRACTIONS: ± 1/64 DECIMALS: ±.01 ±.005 ANGLE: ±1/2°	DRAWING TITLE: DIRECTIONAL COUPLER	
		PROPRIETARY NOTICE: THE INFORMATION IN THIS DRAWING IS PROPRIETARY AND SHALL NOT BE USED OR DISCLOSED WITHOUT WRITTEN PERMISSION FROM MICROWAVE COMMUNICATIONS LABORATORIES INC. (MCLI)	PART NO. CB147-30	
DRAWN:	DATE:	THIRD ANGLE PROJECTION 	CAGE CODE:	DWG NO.
Paiboon Luekhamhan	09-30-2010		OD2L5	85064
APPROVED:	DATE:	DO NOT SCALE THE DRAWING		
T. Nguyen	09-30-2010			