

REVISIONS				
ZONE	REV	DESCRIPTION	DATE	APPROVED

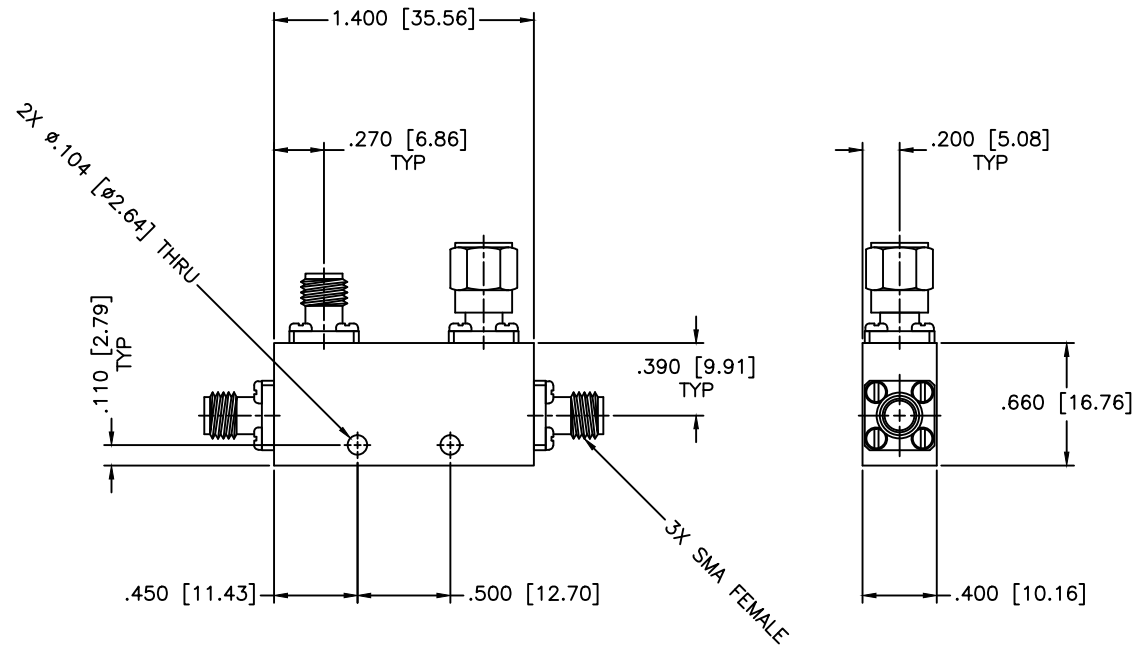

SPECIFICATIONS

Frequency Range: 6–18 GHz
 Coupling: 30±1.0dB
 Frequency Sensitivity: ±0.6dB
 Insertion Loss: 0.6dB Max.
 Directivity: 15dB Min.
 VSWR: 1.50:1 Max.
 Power: 50W
 Operating Temperature: -55°C to +85°C

MATERIAL:	
DRAWN: Paiboon Luekhamhan	DATE: 03-17-2011
APPROVED: T. Nguyen	DATE: 03-17-2011

	MICROWAVE COMMUNICATIONS LABORATORIES INC. 7255 30TH AVE. N. SAINT PETERSBURG, FL 33710 TEL: (727) 344-6254 FAX: (727) 381-6116 http://WWW.MCLI.COM		SHEET:	N/A
	UNLESS OTHERWISE SPECIFIED: TOLERANCES IN (INCHES) OR [mm] (MILLIMETERS) FRACTIONS: ± 1/64 DECIMALS: ±.01 ±.005 ANGLE: ±1/2°		DRAWING TITLE:	DIRECTIONAL COUPLER
PROPRIETARY NOTICE: THE INFORMATION IN THIS DRAWING IS PROPRIETARY AND SHALL NOT BE USED OR DISCLOSED WITHOUT WRITTEN PERMISSION FROM MICROWAVE COMMUNICATIONS LABORATORIES INC. (MCLI)		PART NO.	CB10-30-50	
CAGE CODE:	SIZE:	REV:	DWG NO.	
OD2L5	A	N/A	85587	
DO NOT SCALE THE DRAWING				

