

REVISIONS				
ZONE	REV	DESCRIPTION	DATE	APPROVED

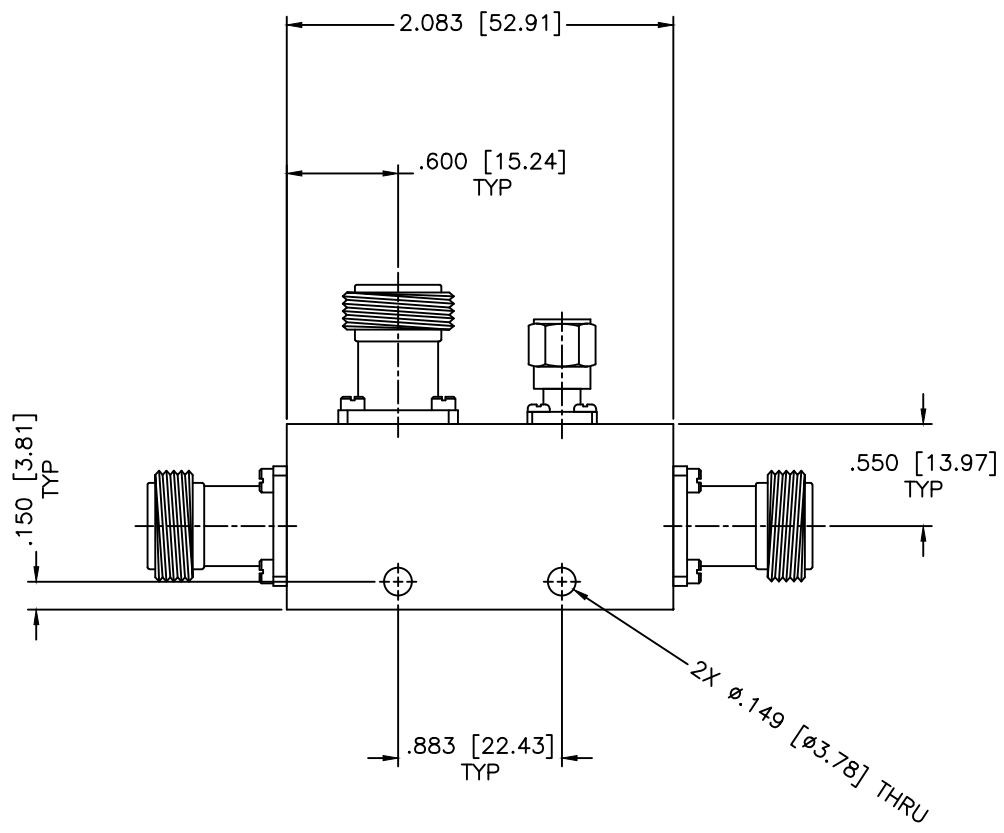
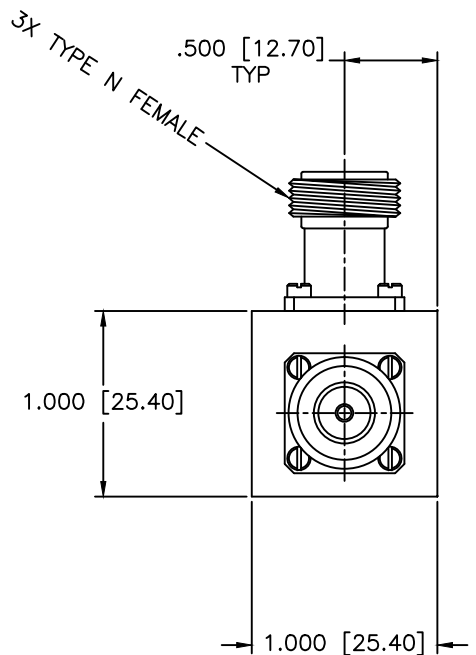

SPECIFICATIONS

Frequency Range: 2.4–2.5 GHz
 VSWR: 1.25:1 Max.
 Coupling: 20±1.0dB
 Insertion Loss: 0.5dB Max.
 Directivity: 20dB Min.
 Frequency Sensitivity: ±0.75dB
 Power Incident, Reflected: 50W, 50W, 1kW Peak

MATERIAL:			MICROWAVE COMMUNICATIONS LABORATORIES INC. 7255 30TH AVE. N. SAINT PETERSBURG, FL 33710 TEL: (727) 344-6254 FAX: (727) 381-6116 http://WWW.MCLI.COM		SCALE:	N/A
			UNLESS OTHERWISE SPECIFIED: TOLERANCES IN (INCHES) OR [mm] (MILLIMETERS) FRACTIONS: ± 1/64 DECIMALS: ±.01 ±.005 ANGLE: ±1/2°		SHEET:	N/A
DRAWING TITLE:		DIRECTIONAL COUPLER				
PART NO.:		C47-20/NF				
DRAWN:	DATE:	PROPRIETARY NOTICE: THE INFORMATION IN THIS DRAWING IS PROPRIETARY AND SHALL NOT BE USED OR DISCLOSED WITHOUT WRITTEN PERMISSION FROM MICROWAVE COMMUNICATIONS LABORATORIES INC. (MCLI)	CAGE CODE:	SIZE:	REV:	DWG NO.:
APPROVED:	DATE:		OD2L5	A	N/A	82368
			DO NOT SCALE THE DRAWING			