

REVISIONS				
ZONE	REV	DESCRIPTION	DATE	APPROVED

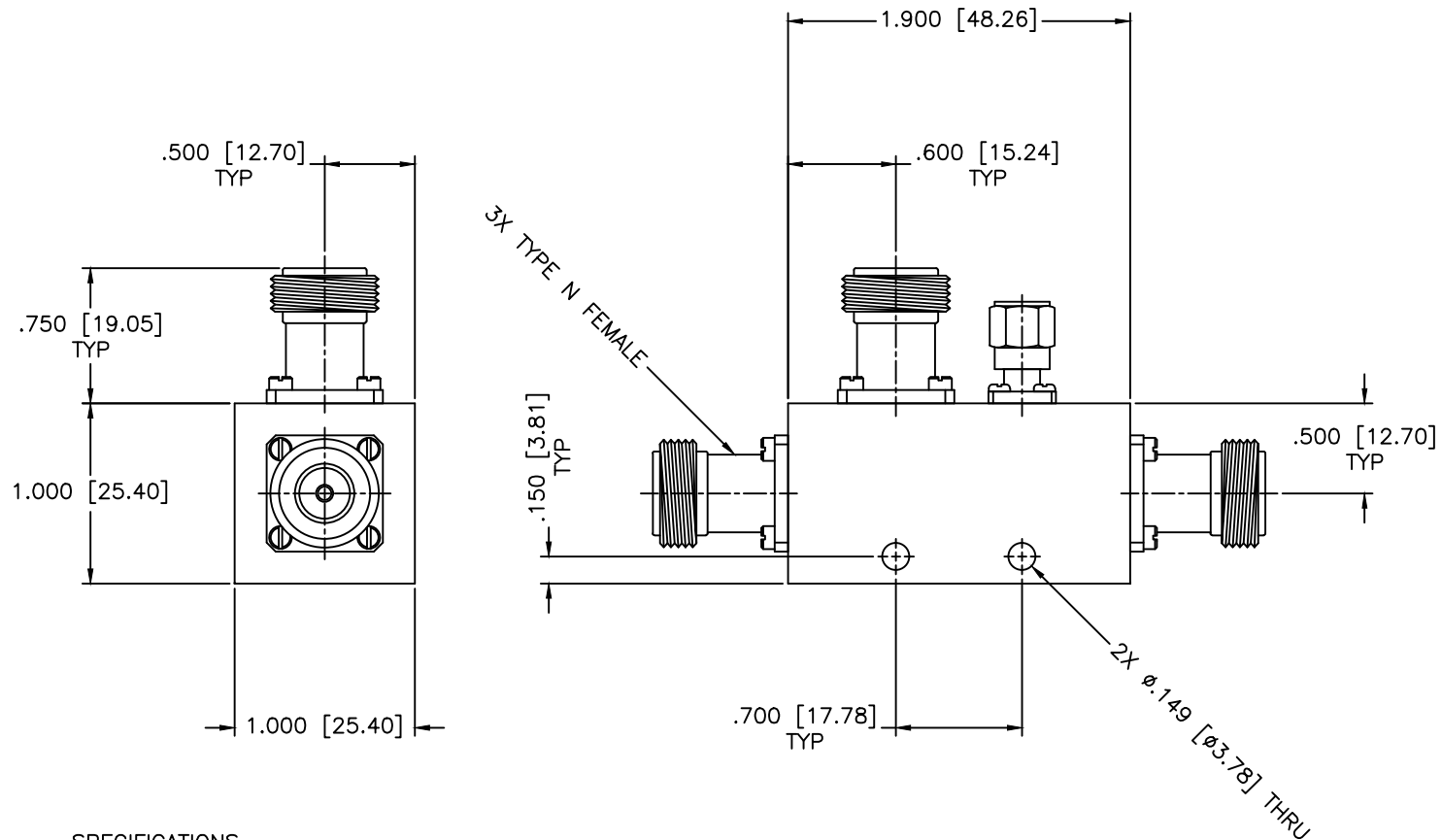

SPECIFICATIONS

Frequency Range: 2.6–5.2 GHz
 Coupling: 20±1.25dB
 Frequency Sensitivity: ±0.75dB
 Insertion Loss: 0.3dB Max.
 Directivity: 18dB Min.
 VSWR: 1.40:1 Max.
 Power Incident, Reflected: 50W, 50W, 3kW Peak

MATERIAL:			MICROWAVE COMMUNICATIONS LABORATORIES INC. 7255 30TH AVE. N. SAINT PETERSBURG, FL 33710 TEL: (727) 344-6254 FAX: (727) 381-6116 http://WWW.MCLI.COM		SCALE: N/A	
			UNLESS OTHERWISE SPECIFIED: TOLERANCES IN (INCHES) OR [mm] (MILLIMETERS) FRACTIONS: ± 1/64 DECIMALS: ±.01 ±.005 ANGLE: ±1/2°		SHEET: N/A	
DRAWING TITLE:		DIRECTIONAL COUPLER				
PART NO.:		C4-20/NF				
DRAWN:	DATE:	PROPRIETARY NOTICE: THE INFORMATION IN THIS DRAWING IS PROPRIETARY AND SHALL NOT BE USED OR DISCLOSED WITHOUT WRITTEN PERMISSION FROM MICROWAVE COMMUNICATIONS LABORATORIES INC. (MCLI)	CAGE CODE:	SIZE:	REV:	DWG NO.:
APPROVED:	DATE:		OD2L5	A	N/A	80400
		THIRD ANGLE PROJECTION	DO NOT SCALE THE DRAWING			