

REVISIONS				
ZONE	REV	DESCRIPTION	DATE	APPROVED

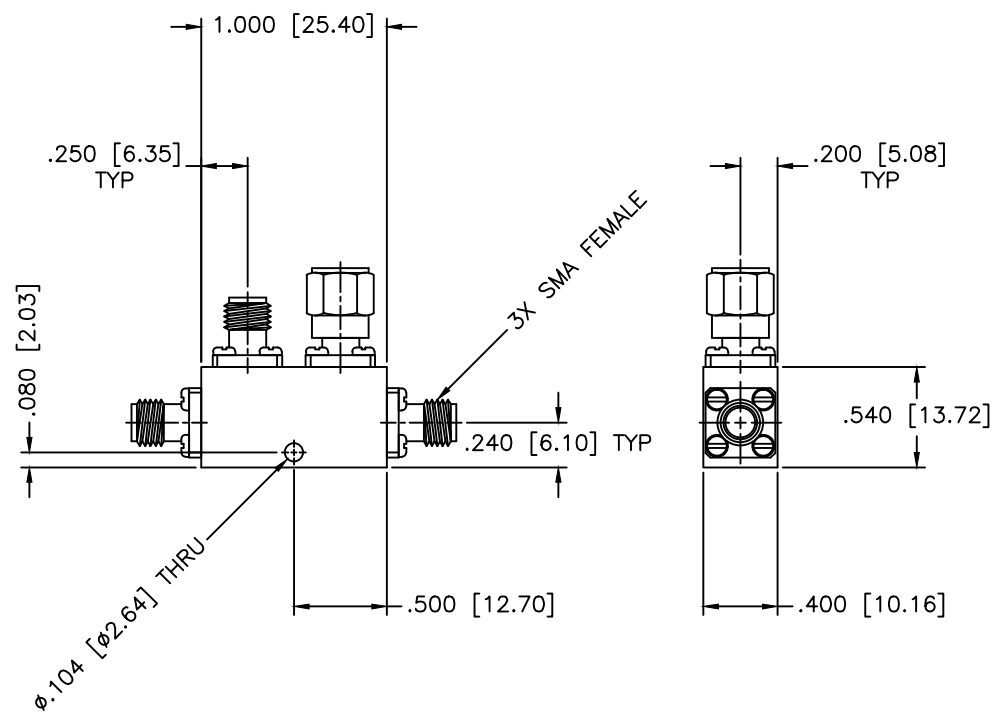

SPECIFICATIONS

Frequency Range: 3.6–4.2 GHz
 Coupling: 10±1.0dB
 Frequency Sensitivity: ±0.3dB
 Insertion Loss: 1.0dB Max.
 Directivity: 15dB Min.
 VSWR: 1.40:1 Max.
 Power Incident, Reflected: 50W, 5W, 3kW Peak

MATERIAL:		MICROWAVE COMMUNICATIONS LABORATORIES INC. 7255 30TH AVE. N. SAINT PETERSBURG, FL 33710 TEL: (727) 344-6254 FAX: (727) 381-6116 http://WWW.MCLI.COM	SCALE:	N/A
			SHEET:	N/A
UNLESS OTHERWISE SPECIFIED: TOLERANCES IN (INCHES) OR [mm] (MILLIMETERS) FRACTIONS: ± 1/64 DECIMALS: ±.01 ±.005 ANGLE: ±1/2°		DRAWING TITLE:		
		DIRECTIONAL COUPLER		
DRAWN:		PART NO.		
Paiboon Luekhamhan		C19-10		
DATE:	09-30-1999	PROPRIETARY NOTICE: THE INFORMATION IN THIS DRAWING IS PROPRIETARY AND SHALL NOT BE USED OR DISCLOSED WITHOUT WRITTEN PERMISSION FROM MICROWAVE COMMUNICATIONS LABORATORIES INC. (MCLI)	CAGE CODE:	SIZE:
APPROVED:	T. Nguyen		OD2L5	A
DATE:	09-30-1999	THIRD ANGLE PROJECTION	REV:	N/A
			DWG NO.	
			80467	
			DO NOT SCALE THE DRAWING	